

Battery Driven Power Tool System for Orthopedics and Traumatology

Battery Power Line II

Instructions for Use



Table of Contents

Introduction	General Information	3
	Drive Units	8
	Universal Battery Charger II	13

Operating Instructions	Battery Pack (battery casing with inserted battery)	14
	Battery Reamer/Drill II (530.705)	22
	Attachments for Battery Reamer/Drill II	23
	Battery Oscillator II (530.710)	39
	Battery Reciprocator II (530.715)	42

Care and Maintenance	General Information	45
	Cleaning and Disinfection	47
	• Preparation prior to Reprocessing	47
	• Manual Cleaning Instructions	48
	• Automated Cleaning Instructions with Manual Pre-cleaning	51
	Maintenance and Lubrication	57
	Inspection and Function Test	63
	Packaging, Sterilization and Storage	64
	Repairs and Technical Service	67
Disposal of Waste	68	

Troubleshooting	69
<hr/>	
System Specifications	75
<hr/>	
Electromagnetic Compatibility	79
<hr/>	
Ordering Information	84

General Information

Intended use

The Battery Power Line II is a battery-powered system to be used for treatment in orthopedic and traumatology surgery, i.e. drilling, reaming, cutting, placing of Kirschner Wires on bone of human skeleton.

Battery Reamer/Drill II



Drilling



Reaming



Kirschner wire insertion



Fixing of cutting block with a pin

Battery Oscillator II



Oscillating sawing

Battery Reciprocator II



Reciprocating sawing

Safety instructions

The surgeon has to evaluate if the machine is suitable for an application, based on power limitation of the machine, attachment and cutting tool regarding bone strength/anatomical situation as well as handling of the machine, attachment and cutting tool regarding bone size. In addition, the contraindications of the implant have to be respected. Please refer to the corresponding surgical techniques of the implant system used.

The Battery Power Line II system is only to be used for patient treatment after careful consultation of the instructions for use. It is recommended that an alternative system is available to use during application, as technical problems can never be completely ruled out.

The Battery Power Line II is designed for use only by physicians and trained medical personnel.

DO NOT use any apparently damaged components.

DO NOT use any component if the packaging is damaged.

DO NOT use this equipment in the presence of oxygen, nitrous oxide or a mixture consisting of flammable anesthetic and air.

To ensure proper operation of the tool, only use Synthes original accessories.

Before first and every use and prior returning for service power tools and their accessories/attachments, excluding the battery, have to be run through the complete reprocessing procedure. Protective covers and films must be fully removed before sterilization.

For the tool to function properly, Synthes recommends that it is cleaned, disinfected and serviced after each use in accordance with the process defined in the "Care and Maintenance" section. Compliance with these specifications can considerably extend the service life of the tool and reduce the risk of malfunction or harm to the user and patient. Only use Synthes Special Oil (519.970) to lubricate the tool.

We recommend using new Synthes cutting tools for every surgical procedure. Efficiently working cutting tools are the basis for successful surgery. Therefore, check used cutting tools after every use for wear and/or damage and replace them if necessary.

Cutting tools must be cooled with irrigation fluid to prevent heat necrosis.

The user of the product is responsible for proper use of the equipment during surgery.

Check proper operation of the tool before using it on the patient.

Unusual Transmissible Pathogens

Surgical patients identified as at risk for Creutzfeldt-Jakob disease (CJD) and related infections should be treated with single-use instruments. Dispose of the instruments used or suspected of use on a patient with CJD after surgery and/or follow the current national recommendations.

To prevent overheating, always respect the specified duty cycles on page 76. High torque of the powerful Reamer/Drill (530.705) must always be observed.

For important information regarding electromagnetic compatibility (EMC) please refer to the "Electromagnetic Compatibility" section in this manual.

The tool is classified as type BF against electrical shock and leakage current. The tool is suitable for use on patients in accordance with IEC 60601-1.

Servicing

This system requires regular maintenance service, at least once a year, in order to maintain its functionality. This service has to be performed by the original manufacturer or an authorized site.

The manufacturer assumes no responsibility for damage resulting from improper operation, neglected or unauthorized maintenance of the tool.

Precautions :

- Always wear personal protective equipment (PPE) including safety goggles when handling with the BPL II system.
- To avoid injuries, the locking mechanism of the tool has to be activated before every manipulation and before placing the tool back down, i.e. the mode switch has to be in the off position.
- Only place the tool in an upright position when changing attachments or cutting tools intraoperatively. The handpiece must be laid on its side when not in use in order to avoid the risk of being dropped or contaminating other instruments.
- Should the machine drop on the floor and have visible defects, do not use it anymore and send it to the Synthes Service Center.
- If a product drops on the floor, fragments may split off. This represents a danger for the patient and user as:
 - these fragments may be sharp.
 - unsterile fragments may enter the sterile field or hit the patient.
- The tool must only be operated with a fully charged battery. Therefore, ensure that the battery is charged in good time. We recommend to install the battery pack just before use in order to prevent unwanted discharge of battery capacity. Furthermore, it is recommended that the battery is placed into the charger immediately after surgery.
- The aseptic transfer is detailed on page 14ff. Alternatively please follow the guidelines provided in the STERRAD/V-PRO sterilization guide (DSEM/PWT/0615/0068). No other sterilization methods are allowed.
- The battery must never be washed, rinsed or dropped. This would destroy the battery with possible secondary damage (explosion hazard!). Only use original Synthes batteries. Further information can be found on page 20ff.
- Never place the BPL II in a magnetic environment since the machine might start unintentionally.
- Should the system have corroded parts, do not use it anymore and send it to the Synthes Service Center.

Locating of the instrument or fragments of instruments

Synthes instruments are designed and manufactured to perform within the scope of their intended use. However, if a Power Tool or accessory/attachment breaks during use, a visual inspection or a medical imaging device (e.g. CT, Radiation Devices, etc.) can aid in locating the fragments and/or components of the instrument.

Accessories/scope of delivery

The Battery Power Line II consists of three different handpieces, a battery casing, a battery and a range of attachments designed for the system.

Please refer to the "Ordering Information" section on page 84ff for an overview of the components of the system.

To charge the batteries only use the corresponding Synthes Universal Battery Charger II (05.001.204).

To reach the specified performance only Synthes cutting tools should be used. These are optimized to meet the specific requirements of the tool. Non Synthes saw blades can considerably reduce the lifetime of the system.

Special auxiliaries such as cleaning brushes (516.101) and Synthes Special Oil (519.970) are available for cleaning and servicing the system.

No oils from other manufacturers must be used. Only Synthes Special Oil (519.970) must be used to lubricate the power tools and attachments. Lubricants with other compositions may cause jamming, have a toxic effect or have a negative impact on the sterilization results. Only lubricate the power tool, the battery casing and the attachments when clean.

Synthes recommends the use of the specifically designed Synthes Washing Baskets (68.001.620, 68.001.625) or Synthes Vario Case (689.202) to sterilize and store the system. Furthermore, the Washing Baskets (68.001.620, 68.001.625) can be used for the automated cleaning procedure. Further information can be found on page 51ff.

Storage and transport

Only use the original packaging for dispatch and transport as otherwise damage may occur. If the packing material is no longer available, please contact your local Synthes office.

Please refer to the guidelines for transporting Li-Ion batteries when returning them to the Synthes Service Center.

Do not store or transport batteries haphazardly in a box or drawer where they may short-circuit each other or be short-circuited by other metal objects. This can damage the batteries and generate heat, which can cause burns.

For storage and transport environmental conditions please refer to the section "System Specification" on page 75.

Warranty/Liability

The warranty for the tools and accessories does not cover damage of any kind resulting from wear, improper use, improper reprocessing and maintenance, damaged seal, use of non Synthes cutting tools and lubricants or improper storage and transport.

The manufacturer excludes liability for damage resulting from improper use, neglected or unauthorized maintenance or servicing of the tool.

For further information on the warranty please contact your local Synthes office.

Explanation of symbols used

The following symbols are applied to the device or individual components. Information on additional symbols is given in the relevant sections of this document.



Caution



Consult the provided instructions for use before operating the device.



The device is classified as type BF against electrical shock and leakage current. The device is suitable for use on patients according to the standards defined by IEC 60601-1.



Indicates Environment Friendly Use Period of 5 years in China.



Indicates Environment Friendly Use Period of 10 years in China.



Do not immerse device in liquids.



Product is UL Classified to the requirements of both the United States and Canada



The device meets the requirements of directive 93/42/EEC for medical devices. It is authorized by an independent notified body for which it bears the CE symbol.



The European Battery Directive 2006/66/EC applies to this device. See section "Disposal of Waste" on page 68. This device contains Lithium-Ion batteries that should be disposed of in accordance with environment protection requirements. Please observe national regulations. See section entitled "Disposal of Waste" on page 68.



The European directive 2012/19/EC on waste electrical and electronic equipment (WEEE) applies to this device. This device contains materials that should be disposed of in accordance with environment protection requirements. Please observe national regulations. See section entitled "Disposal of Waste" on page 68.

S9

Duty cycle type according to IEC 60034-1.

IP X4

Ingress protection rating according to IEC 60529.



Locked symbol. Drive Unit is off for safety.



Manufacturer



Date of manufacture



Non sterile



Temperature



Relative humidity



Atmospheric pressure



Do not use if package is damaged.

Drive Units

Battery Reamer/Drill II (530.705)

Speed (without attachment)	0–340 rpm (maximum speed varies with attachment)
Torque (without attachment)	0–15 Nm (maximum torque varies with attachment)
Weight of handpiece (including battery pack)	1565 g/3.4 lbs
Cannulation	∅ 4.0 mm
Protection against electric shock	BF Ⓜ
Protection against water ingress	IP X4
Cleaning brush (516.101) and Synthes Special Oil (519.970) included	

Technical data is subject to tolerances.

Attachment release ring
Facilitates one-handed removal of attachments

Variable-speed trigger
Controls rotational speed

Release buttons
Both release buttons must be pressed simultaneously to remove battery casing

Battery casing
Protects sterile environment from contamination by non-sterile battery

Battery casing locks
To open and close the lid of the battery casing and prevent the casing from opening during surgery. Both battery casing locks must be pressed simultaneously to open and close the lid.

Mode switch

Locked symbol
Drive unit is off for safety

FWD
Clockwise rotation

REV
Counterclockwise rotation

Battery Oscillator II (530.710)

Speed	0–12 000 oscillations per minute
Deflection	4.5° (0°+/-2.25°)
Weight of handpiece (including battery pack)	1685 g/3.7 lbs
Protection against electric shock	BF \square
Protection against water ingress	IP X4
Synthes Special Oil (519.970) included	

Technical data is subject to tolerances.



Battery Reciprocator II (530.715)

Speed	0–14 000 oscillations per minute
Stroke	4 mm
Weight of handpiece (including battery pack)	1675 g/3.6 lbs
Protection against electric shock	BF \square
Protection against water ingress	IP X4
Synthes Special Oil (519.970) included	

Technical data is subject to tolerances.



Battery for Battery Power Line II

Art. no. 530.630

Type Li-Ion (Lithium Ion)

Voltage 14.8 V

Capacity 1.5 Ah/22.2 Wh

Charging Time typically <60 minutes

Technical data is subject to tolerances.

Note: For further information on the correct method of charging, storing and using the battery, please refer to page 20ff.



Compatibility between BPL and BPL II batteries

Existing BPL handpieces are compatible with BPL II batteries

The existing BPL handpieces (530.605, 530.610, 530.615) can be used with the new BPL II battery (530.630), battery casing (530.690) and sterile cover (530.660) as seen in Fig. 1.



Existing BPL batteries are compatible with BPL II handpieces

The existing BPL battery (530.620), battery casing (530.680) and sterile cover (530.650) can be used with the new BPL II handpieces (530.705, 530.710, 530.715) as seen in Fig. 2.

Note: All BPL/BPL II attachments are fully compatible with the BPL/BPL II handpieces (530.605/530.705).

Note: Technical data is subject to tolerances and may vary when combining the two systems.



Universal Battery Charger II

The Universal Battery Charger II (05.001.204) includes four independent charging bays. Each charging bay has three slots; the Battery Power Line II battery (530.630) fits into the top slot.

Note: In order that the BPL II battery can be recognized and charged by the UBC II, a minimum of firmware version 14.0* is required. If necessary, send the charger to a Synthes representative for a firmware update.

For further information on the Universal Battery Charger II please consult the relevant Instructions for Use (DSEM/PWT/1114/0050) or contact your local Synthes office.

The BPL II battery cannot be charged with the Universal Battery Charger (item number 530.600 or 530.601).

- 1 Charging bays (4)
- 2 Symbols for battery type
- 3 ON/OFF display
- 4 Control display for each charging bay
- 5 Ventilation holes
- 6 Ventilation holes
- 7 Power switch
- 8 Fuses: 2 x 5 AT/250 V
- 9 Power cord connection
- 10 Symbol for BPL and BPL II batteries (530.620 or 530.630)

Front view



Rear view

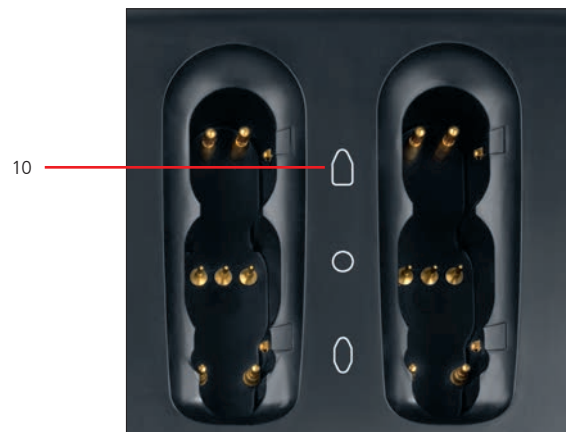

* Sticker as shown on the underside of the charger with firmware version 14.0:

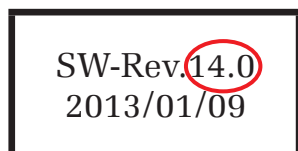

Battery Pack

(battery casing with inserted battery)

Synthes non-sterile batteries and advanced charging technology optimize intraoperative battery capacity, maximize battery lifespan and shorten turnaround time. One Universal Battery Charger II (05.001.204) for multiple Synthes battery-driven systems simplifies the charging process. Simple aseptic technique preserves the sterile field when assembling the battery pack.

The aseptic transfer is detailed below. Alternatively use the STERRAD/V-PRO sterilization guide if preferred (DSEM/PWT/0615/0068).

Instruments

530.630	Battery for Battery Power Line II
530.660	Sterile Cover for Battery Power Line II
530.690	Battery Casing for Battery Power Line II

Assembling and inserting the battery pack

Scrubbed person

Open the lid of the battery casing as shown in Fig. 1.

Ensure the lid of the battery casing is fully open (Fig. 2).



Figure 1



Figure 2

Ensure that the lid of the battery casing is facing towards the scrubbed person (Fig. 3).

Position the sterile cover securely on top of the battery casing (Fig. 4).

Notes:

- The sterile cover helps to guide the battery into the battery casing and prevents contamination of the sterile casing by the non-sterile battery.
- Sterilize the sterile cover after each use to ensure aseptic conditions when inserting the non-sterile battery into the sterile battery casing.

Precautions:

- If the non-sterile battery contacts the outside of the battery casing, the battery casing must be cleaned and resterilized before being used in the operating room.
- Do not insert the non-sterile battery into the battery casing whilst a handpiece is attached.



Figure 3



Figure 4

Circulating person

Insert the non-sterile battery through the sterile cover into the battery casing (Fig. 5a). Press down on the battery to ensure it is fully seated (Fig. 5b).

Note: The shape of the battery ensures that it is inserted with the correct pole alignment. The circulating person must not touch the outside of the battery casing.

Remove the sterile cover from the battery casing (Fig. 6).

Precaution: Avoid all contact with the outside of the battery casing in order not to contaminate it. Should the non-sterile battery or the circulating person's hand come into contact with the outside of the battery casing, it must be cleaned and resterilized before being used in the operating room.



Circulating person

Scrubbed person

Figure 5a



Circulating person

Scrubbed person

Figure 5b



Circulating person

Scrubbed person

Figure 6

Scrubbed person

Close the battery casing (Figs. 7a and 7b). Both battery casing locks must be pressed simultaneously to close the lid of the battery casing (Fig. 7a).

Note: Ensure that both battery casing locks engage and that the lid of the battery casing is closed properly. Always ensure that the lid of the battery casing is totally closed before using the system.

Precaution: Do not contact the non-sterile battery or the inside of the battery casing in order to avoid contamination. Should the scrubbed person come into contact with either the non-sterile battery or the inside of the battery casing, they must be scrubbed again. Should the battery casing be contaminated it must be cleaned and resterilized before being used in the operating room.

Notes:

- Normally, one fully charged battery has sufficient capacity for an entire operation. As a precaution, a second battery pack (battery casing with inserted battery) should be kept ready, so that the battery pack can be quickly exchanged under sterile conditions during surgery if necessary.
- Never open a battery casing intraoperatively to insert a new battery. Always replace the whole battery pack with another battery pack prepared before the start of the surgery.



Figure 7a



Figure 7b

Insert the battery pack into the drive unit, ensuring the contacts on the battery pack align with the contacts in the recess of the drive unit (Fig. 8). Press firmly to ensure the battery pack is engaged correctly, and check by pulling lightly downward on the battery pack.

Precautions:

- For safety reasons, the battery pack can only be inserted fully when it is in the correct orientation.
- To prevent injuries, the mode switch of the drive unit should always be in the off position when inserting or removing the battery pack.
- Installing the battery pack just before use prevents unwanted discharge of battery capacity.



Figure 8

Removing and disassembling the battery pack

Press both release buttons simultaneously on the drive unit to remove the battery pack (Fig. 9).

Open the casing by pressing both battery casing locks and remove the battery or hold open the battery casing to allow another person to remove the battery (Fig. 10).

Ensure that the battery does not touch the exterior of the battery casing in order to avoid contaminating the battery. If this occurs follow the information in the "Care and Maintenance" section starting on page 45.

Store battery in Universal Battery Charger II (05.001.204) when not in use (Fig. 11).

Alternatively please follow the guidelines provided in the STERRAD/V-PRO sterilization guide (DSEM/PWT/0615/0068). No other sterilization methods are allowed.

Precautions: Do not wash, rinse, drop or apply force to the battery (530.630). This will destroy it with possible secondary damage.



Figure 9



Circulating person

Scrubbed person

Figure 10



Figure 11

Charging, storing and using batteries

Charging

Only use the Synthes Universal Battery Charger II (05.001.204) to charge the battery. Using a charger that does not originate from Synthes can damage the battery.

In order that the BPL II battery can be recognized and charged by the UBC II, a minimum of firmware version 14.0 is required. If necessary, send the charger to a Synthes representative for a firmware update. Further information can be found on page 13.

The BPL II battery cannot be charged with the Universal Battery Charger (item number 530.600 or 530.601).

The batteries should always be charged before use.

Place the battery into the charger immediately after surgery.

Charge the batteries within an ambient temperature range of 10°C/50°F to max. 40°C/104°F.

Keep the charger and the batteries clean and in a cool and dry place.

Detailed information on the Universal Battery Charger II can be found in the Instructions for Use (DSEM/PWT/1114/0050).

Storage

Always recharge the Li-Ion Battery for Battery Power Line II (530.630) immediately after each use. Do not store an empty battery as this will shorten the life span and will not be covered by warranty.

When the battery is not in use, store it in the Synthes Universal Battery Charger II (05.001.204). This will guarantee that the battery is always fully charged and ready to use.

The Universal Battery Charger II should always be turned on when a battery is in the charging bay. This ensures availability of charged batteries.

Use

Do not remove battery from its original packaging until required for use.

Do not drop or apply force to the battery.

This will destroy it with possible secondary damage.

Only use the battery for its intended use. Do not use any battery which is not designed for use with the equipment.

The power tool must only be operated with a fully charged battery. Therefore the batteries should always be charged before use.

Only insert the battery pack directly before using the power tool. This saves battery energy and prevents having to change it during surgery.

Do not use a faulty or damaged battery, as this may damage the power tool. Test the status of the battery using the Universal Battery Charger II (DSEM/PWT/1114/0050).

If the drive unit is defect (e.g. short-circuited) do not insert a battery, as this will blow the internal fuse and cause damage to the battery. Send the drive unit and battery to the Synthes Service Center.

Place the battery into the charger immediately after surgery.

Do not short-circuit a battery. Do not try to measure the short-circuit. This will blow the internal fuse of the battery with irreversible damage of the battery.

Do not store or transport batteries haphazardly in a box or drawer where they may short-circuit each other or be short-circuited by other metal objects. This can damage the batteries and generate heat, which can cause burns.

Batteries give their best performance when they are operated at normal room temperature (20°C/68°F +/- 5°C/9°F).

Follow the information in the “Care and Maintenance” section starting on page 45 as well as the Instructions for Use of the Synthes Universal Battery Charger II (DSEM/PWT/1114/0050).

Precautions:

- The battery must never be washed, rinsed or dropped. This would destroy the battery with possible secondary damage.
- Generally, medical power tools will heat up if in constant use. The cool down times should be observed, see “Duty Cycle” section on page 76, in order to prevent the power tool from exceeding its acceptable surface temperature.
- In case of cell leakage, do not allow the leaking fluid to come into contact with skin or eyes. In case of contact, wash the affected area with copious amounts of water and seek medical advice.
- Faulty batteries must not be reused and should be disposed of in an environmentally friendly manner and in accordance with national regulations.
- Please refer to the regulations for transporting Li-Ion batteries when returning them to the Synthes Service Center.

Warnings:

- Risk of fire, explosion and burns. Do not disassemble, crush, heat above 60°C/140°F or incinerate the battery cells.
- Never expose batteries to temperatures over 60°C/140°F. The maximum exposure time at 60°C/140°F is 72 hours.
- Do not dismantle, open or shred batteries.

Battery Reamer/Drill II (530.705)

For clockwise rotation, turn the mode switch to the "FWD" position.

For counterclockwise rotation, turn the mode switch to the "REV" position.

The single variable-speed trigger allows control of the speed from 0 to the maximum rpm. Maximum torque and speed vary, depending on the attachment (see pages 23 ff). Ensure that the correct attachment is used for each operation in terms of speed and torque.

For further information on the System Specifications and Duty Cycle please refer to page 76f.



For clockwise rotation, turn the mode switch to the FWD position.



For counterclockwise rotation turn the mode switch to the REV position.



For safety, turn the mode switch to the OFF position.

Attachments for Battery Reamer/Drill II

Instrument

530.705 Battery Reamer/Drill II

Precaution: To prevent injuries, the mode switch of the drive unit should always be in the “OFF” position when inserting or removing attachments and cutting tools.

Please observe the safety instructions and warnings stated in the instructions when working with attachments. Only use original Synthes attachments. Damage resulting from the use of attachments from other manufacturers is not covered by the warranty.

Insert attachment

Insert the attachment into the coupling of the Battery Reamer/Drill II, aligning the positioning pins of the attachment with the grooves on the attachment release ring (Fig. 1).

Turn the attachment release ring in the direction of the arrow and push the attachment until it engages in place (Fig. 2). If the attachment does not engage properly then rotate the attachment gently until the drive shaft engages.

Check that the attachment coupling is closed properly by lightly pulling the attachment.

Remove attachment

Turn the attachment release ring in the direction of the arrow and remove the attachment.

Note: Properly functioning tools are essential to the success of an operation. For this reason, used tools must be checked for wear and/or damage after each use and replaced if necessary.



Figure 1



Figure 2

Color marking on the attachments

Some rotating attachments are available in two different speeds for drilling and reaming, respectively. The attachments are marked accordingly (Figs. 1 and 2):

Drill attachments:

Blue color marking and inscribed with **DRILL**

All drilling speed attachments are geared to increase the maximum drive speed to **930 rpm** while reducing the maximum torque to **6.0 Nm**.

Ream attachments:

Red color marking and inscribed with **REAM**

All reaming speed attachments transfer the speed and torque of the drive unit with a maximum speed of **340 rpm** and a maximum torque of **15 Nm**.

Technical data is subject to tolerances.

Please refer to notes and precautions on page 25.
The following notes apply to all attachments.



Figure 1: Chuck with drilling speed (text DRILL and blue color marking)



Figure 2: Chuck with reaming speed (text REAM and red color marking)

Notes:

- Always turn the mode switch to “OFF” position when inserting/removing attachments and cutting tools.
- If the attachment does not engage properly then rotate the attachment gently until the drive shaft engages.
- All BPL/BPL II attachments are fully compatible with the BPL/BPL II handpieces (530.605/530.705).
- After inserting a cutting tool, always check that it is properly engaged by pulling it.
- Only use original Synthes attachments and cutting tools.
- Check the cutting tools for wear and/or damage after each use, and replace if necessary. Synthes recommends that cutting tools are only used once for patient safety.
- The use of irrigation fluid is recommended to cool the cutting tools and prevent heat necrosis.
- Damage resulting from the use of attachments and cutting tools from other manufacturers is not covered by the warranty.

Precaution:

- During reaming procedures high torque values must be provided by the power tool to the reaming head to allow efficient bone removal. In cases where the reaming head is suddenly blocked these high torque values can be transferred onto the user's hands, wrists and/or the patient's body. In order to prevent injuries it is therefore essential that:
 - The power tool is held in an ergonomic position with a firm grip.
 - If the reamer head blocks, the speed trigger is released immediately.
 - The correct function of the speed trigger (immediate stop of system when the trigger is released) is checked before the reaming process.

Drill Chuck with Key, Drill Speed (530.730)
Drill Chuck with Key, Ream Speed (530.732)

Maximum speed:

Drilling: approx. 930 rpm
Reaming: approx. 340 rpm

Maximum torque:

Drilling: approx. 6.0 Nm
Reaming: approx. 15.0 Nm

Cannulation:

Drilling: Ø 3.2 mm
Reaming: Ø 4.0 mm

Accepts round and triangular shafts up to
Ø 7.3 mm

Technical data is subject to tolerances.

Insert instrument

Open the chuck jaws by turning the key (510.191) counterclockwise, or by manually turning the collar (Fig. 1).

Insert the instrument shaft into the opened chuck.

Close the chuck manually by rotating the collar, keeping the instrument shaft centered in the jaws. Tighten the chuck by turning the key clockwise (Fig. 2).

Precaution: To ensure secure fixation of the instrument, make sure the toothed rims on the drill chuck and key are not worn. Replace damaged or worn components. Only use original Synthes key.

Remove instrument

Turn the key counterclockwise to open the jaws. Remove the instrument.

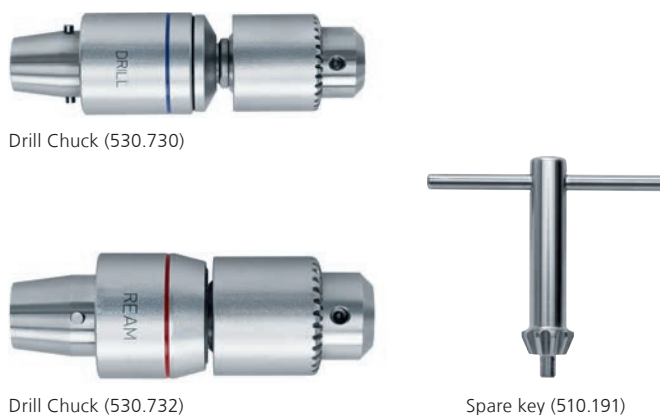

Figure 1



Figure 2

Drill Chuck, Keyless, Drill Speed (530.731)

Maximum speed:
approx. 930 rpm

Maximum torque:
approx. 6.0 Nm

Cannulation:
Ø 3.2 mm

Accepts round and triangular shafts up to
Ø 7.3 mm

Technical data is subject to tolerances.

Insert instrument

Open the chuck jaws by holding on to the retaining ring and manually turning the chuck (Fig. 1).

Insert the instrument shaft into the opened chuck.

Close the chuck by holding on to the retaining ring and manually turning the chuck in the opposite direction (Fig. 2).

Ensure the instrument shaft is centered in the chuck.

Remove instrument

Open the chuck jaws by holding on to the retaining ring and manually turning the chuck. Remove the instrument.



Figure 1



Figure 2

**AO/ASIF Quick Coupling for drill bits,
Drill Speed (530.750)**

Maximum speed:
approx. 930 rpm

Maximum torque:
approx. 6.0 Nm

Cannulation:
Ø 2.0 mm

Accepts cutting tools and instruments with an AO/ASIF quick coupling fitting

Technical data is subject to tolerances.

Insert instrument

Introduce the instrument into the attachment, then push and turn the instrument until it locks in place (Fig. 1). Pull lightly on the instrument to ensure it is secure.

Note: It is not necessary to pull back the collar of the attachment to insert the instrument.

Remove instrument

Pull back the collar of the attachment and remove the instrument (Fig. 2).



Figure 1



Figure 2

**Quick Coupling for DHS/DCS Triple Reamers,
Drill Speed (530.760)**

Maximum speed:
approx. 930 rpm

Maximum torque:
approx. 6.0 Nm

Cannulation:
Ø 3.2 mm

Accepts cutting tools and instruments with a large quick coupling fitting. These include DHS/DCS triple reamers, large quick coupling screwdriver shafts, large quick coupling cannulated drill bits for Synthes intramedullary nailing systems and the Synthes Reamer/Irrigator/Aspirator (RIA) system.

Technical data is subject to tolerances.

Insert instrument

Push forward on the collar of the attachment and insert the instrument, turning it slightly to align the instrument (Fig. 1).

Release the collar, pulling lightly on the instrument to ensure it is secure.

Remove instrument

Push forward on the collar of the attachment and remove the instrument (Fig. 1).



Figure 1

Drilling/Reaming Attachments

Maximum speed:

Drilling: approx. 930 rpm
Reaming: approx. 340 rpm

Maximum torque:

Drilling: approx. 6.0 Nm
Reaming: approx. 15 Nm

Cannulation:

Drilling: Ø 3.2 mm
Reaming: Ø 4.0 mm

Technical data is subject to tolerances.

Hudson Quick Coupling (530.792), Drill speed Hudson Quick Coupling (530.782), Ream speed

Accepts cutting tools and instruments with a Hudson fitting.



Trinkle Quick Coupling, modified (530.793), Drill speed Trinkle Quick Coupling, modified (530.783), Ream speed

Accepts cutting tools and instruments with a modified Trinkle fitting.



Trinkle Quick Coupling (530.794), Drill speed
Trinkle Quick Coupling (530.784), Ream speed
Accepts cutting tools and instruments with a Trinkle fitting.



Trinkle QC XXL, modified (530.795), Ream speed
Accepts cutting tools and instruments with a large, tapered, modified Trinkle fitting.



Insert instrument

Pull back the collar of the attachment and insert the instrument, turning it slightly to align the instrument (Fig. 1).

Release the collar, pulling lightly on the instrument to ensure it is secure.

Remove instrument

Pull back the collar of the attachment and remove the instrument (Fig. 1).



Figure 1

AO/ASIF Quick Coupling for Reamers, Reaming Speed (530.780)

Maximum speed:
approx. 340 rpm

Maximum torque:
approx. 15 Nm

Cannulation:
Ø 4.0 mm

Accepts cutting tools and instruments with an AO reaming fitting, including intramedullary reaming shafts with the AO reaming fitting.

Technical data is subject to tolerances.

Insert instrument

Insert the instrument into the attachment and turn it until it locks in place.
Pull lightly on the instrument to ensure it is secure.

Note: It is not necessary to pull back the collar of the attachment to insert the instrument.

Remove instrument

Pull back the collar of the attachment and remove the instrument (Fig. 1).



Figure 1

**Quick Coupling for Kirschner Wires and for Pins,
Drill Speed (530.791)**

Maximum speed:
approx. 930 rpm

Maximum torque:
approx. 6.0 Nm

Cannulation:
Ø 4.0 mm

Allows insertion and removal of Kirschner wires and
guide pins with diameters from Ø 1.5 mm to 4.0 mm,
in any length (as shown on page 3).

Technical data is subject to tolerances.

Please refer to page 34 for instructions on insertion and
removal of Kirschner wire/guide pin.



Insert Kirschner wire/guide pin into attachment

Set the appropriate diameter range on the attachment adjusting sleeve. To adjust, push in the head of the attachment and then turn to the required diameter (Fig. 1).

Insert the wire/pin into the front of the attachment (Fig. 2). Adjust the working length by pulling in the wire/guide pin.

Note: The attachment is spring-loaded to prevent the wire/pin from falling out.

Insert Kirschner wire/guide pin into bone

Pull the attachment lever toward the drive unit to grip the wire/pin (Fig. 3).

Set the mode switch on the drive unit to FWD (forward) and press the trigger to insert the wire/pin.

Release the lever to reposition the attachment on the wire/pin, if required.

Remove Kirschner wire/guide pin from bone

Set the appropriate diameter range on the attachment adjusting sleeve. To adjust, push in the head of the attachment and then turn to the required diameter (Fig. 1).

Slide the attachment over the wire/pin.

Set the mode switch on the drive unit to REV (reverse).

Pull the attachment lever toward the drive unit to grip the wire/pin (Fig. 3).

Press the trigger while pulling backward to remove the wire/pin from the bone.

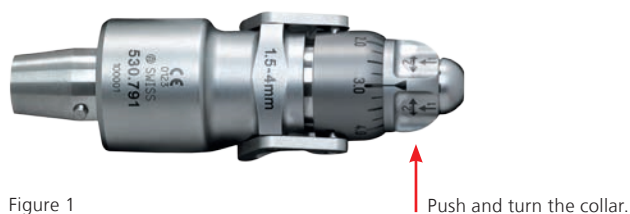

Figure 1



Figure 2



Figure 3

Quick Coupling for Pins, Drill Speed (530.796)

Maximum speed:

approx. 930 rpm

Maximum torque:

approx. 6.0 Nm

Cannulation:

Ø 3.2 mm

Dedicated attachment to fix knee replacement cutting blocks with a pin (as shown on page 3).

Allows insertion and removal of Ø 3.2 mm guide pins with round, triangular and flat shafts.

Technical data is subject to tolerances.

Insert guide pin into attachment

Insert a Ø 3.2 mm guide pin into the front of the attachment (Fig. 1).

Note: The attachment is spring-loaded to prevent the guide pin from falling out.

Insert guide pin into bone

Pull the attachment lever toward the drive unit to grip the pin (Fig. 2).

Set the mode switch on the drive unit to FWD (forward) and press the trigger to insert.

Release the lever to reposition the attachment on the pin, if required.

Remove guide pin from bone

Slide the attachment over the pin.

Set the mode switch on the drive unit to REV (reverse).

Pull the attachment lever toward the drive unit to grip the pin (Fig. 2).

Press the trigger while pulling backward to remove the pin from the bone.

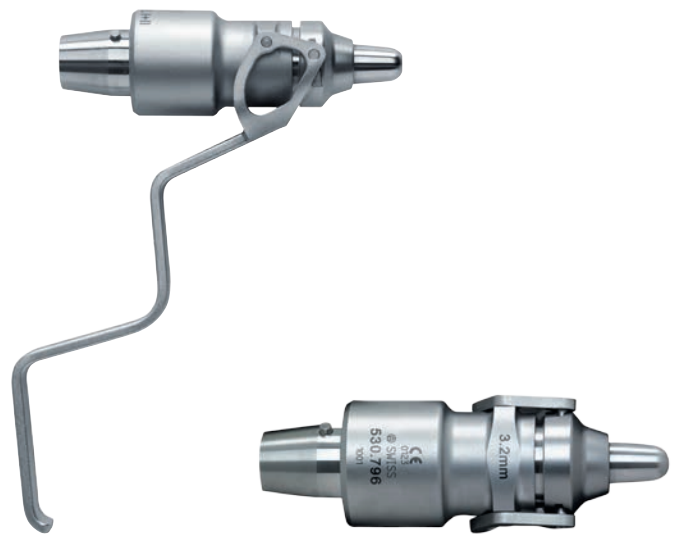

Figure 1



Figure 2

Radiolucent Drive (511.300) and Adapter for Radiolucent Drive (530.741)

Maximum speed:
approx 1100 rpm

Maximum torque:
approx. 1.3 Nm

Technical data is subject to tolerances.

Instruments

530.705	Battery Reamer/Drill II
530.741	Adapter for Radiolucent Drive
511.300	Radiolucent Drive

The Adapter for Radiolucent Drive allows the Radiolucent Drive to be used with the Battery Reamer/Drill II.

Assemble Radiolucent Drive

Insert the Adapter for Radiolucent Drive into the Battery Reamer/Drill II.

Slide the Radiolucent Drive over the Adapter and twist until the drive shaft engages.

Rotate the Radiolucent Drive into the desired working position. Support the drive with your free hand.

Disassemble Radiolucent Drive

Pull the Radiolucent Drive off the Adapter.

Turn the attachment release ring in the direction of the arrow and remove the Adapter for Radiolucent Drive.



511.300



530.741



530.705

Insert drill bits

1. Pull the ring on the Radiolucent Drive forward and push the drill bit into the coupling as far as it can go while rotating it slightly (Fig. 1).
2. Engage the ring on the attachment back to fix the drill bit.

Check if the drill bit is seated correctly by gently pulling on it.

Remove drill bits

To remove the drill bit execute step 1 and 2 above in reverse order.

Using the Radiolucent Drive

Before positioning the Radiolucent Drive, align the image intensifier until the distal locking hole of the medullary nail is round and easily visible (Fig. 2).

After the incision, position the Radiolucent Drive and center the drill bit tip over the locking hole. On the monitor of the image intensifier, you can see both the drill bit and the target rings of the drive.

Swing the drive up and center it precisely so that the drill bit appears as a round point and the locking hole is visible around it. The target rings also assist centering. The locking hole can now be drilled directly (Figs. 3 and 4).

For further information on the Radiolucent Drive and on the special 3-flute spiral drill bits please consult the relevant Instructions for Use (DSEM/PWT/0417/0167) or your local Synthes office.

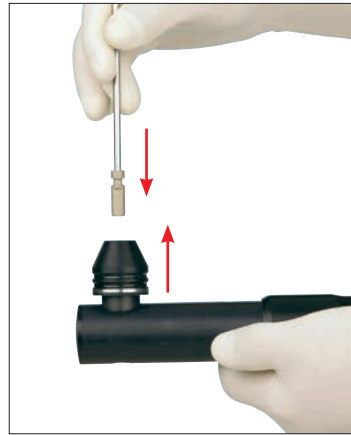

Figure 1



Figure 2

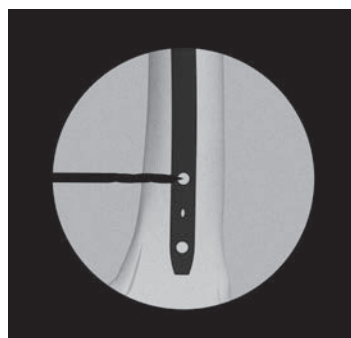

Figure 3



Figure 4

Notes:

- Grip the coupled Radiolucent Drive tightly when switching on the power tool, particularly if the power tool is held face down.
- Only special 3-flute spiral drill bits can be used. Your Synthes representative will provide you with additional information on which drill bits can be used.
- Handle the Radiolucent Drive with great care. Do not allow contact between the drill bit and the medullary nail.
- Depending on the setting of the image intensifier, a zone may appear in the rear of the Radiolucent Drive that is not radiolucent. However, this does not inhibit aiming and working with the device.
- To protect the gears, the Radiolucent Drive is equipped with a slip clutch that disengages in case of an overload and emits an audible rattling noise.
- The following procedures can cause an overload:
 - Correcting the drilling angle when the cutting edges of the drill bit are completely in the bone.
 - Hitting the nail with the drill bit.
- Drilling can continue after making the following corrections:
 - Correcting the drilling angle: Remove the drill bit until the flutes are visible and then restart the drilling.
 - Hitting a nail: Remove the drill bit until the flutes are visible, and reaim the drill bit or exchange the drill bit if necessary.

Battery Oscillator II (530.710)

To operate the drive unit, turn the mode switch to the "ON" position.

The single variable-speed trigger allows control of the oscillating frequency from 0 to 12 000 oscillations per minute. When the trigger is released, the power tool stops immediately. Ensure the drive unit is running prior to contacting the bone. Optimal sawing performance is achieved by gently moving back and forth in the plane of the saw blade, allowing the blade to oscillate freely slightly beyond the bone.

Precaution: To prevent injuries, the mode switch of the drive unit should always be in the off position when inserting or removing saw blades, or adjusting the sawing plane.

For further information on the System Specifications and Duty Cycle, please refer to page 76f.



Locked symbol
Drive unit is off for safety



ON
Drive unit is on for sawing

Insert saw blade

Fully open the saw blade coupling by turning the locking knob.

Insert an oscillating saw blade into the coupling.

Turn the locking knob in the opposite direction to secure the saw blade. Tighten the locking knob (Fig. 1). Always check that the saw blade is properly engaged by pulling it.

Adjust sawing plane

Pull the sliding sleeve back and rotate the saw head to adjust the sawing plane (adjustable through 360° in 45° increments, Fig. 2).

Release the sliding sleeve and turn the saw head slightly until it locks in place.



Figure 1



Figure 2

Remove saw blade

Open the saw blade coupling fully by twisting the locking knob and remove the oscillating saw blade (Fig. 3).

Instructions for handling saw blades

Synthes recommends using a new saw blade for each operation to ensure that the saw blade is optimally sharpened and clean.

The following risks are associated with used saw blades:

- Thermal necrosis caused by excessive heat build-up
- Infection caused by residues
- Extended cutting time due to poor sawing performance
- Potentially, splintering of the teeth or the saw blade

The use of irrigation fluid is recommended to cool the cutting tools and prevent heat necrosis.

Check the cutting tools for wear and/or damage after each use, and replace if necessary. For optimal performance only use Synthes saw blades. These are optimized to meet the specific requirements of the tool. Non Synthes saw blades can considerably reduce the lifetime of the system.

Detailed ordering information on saw blades for the Battery Power Line II system can be found in the brochure "Saw Blades" (DSEM/PWT/0514/0004).



Figure 3

Battery Reciprocator II (530.715)

To operate the drive unit, turn the mode switch to the "ON" position.

The single variable-speed trigger allows control of the reciprocating frequency from 0 to 14 000 oscillations per minute. When the trigger is released, the tool stops immediately. Ensure the drive unit is running prior to contacting the bone. Optimal sawing performance is achieved by gently moving back and forth in the plane of the saw blade, allowing the saw blade to reciprocate freely slightly beyond the bone.

Precaution: To prevent injuries, the mode switch of the drive unit should always be in the off position when inserting or removing saw blades, or adjusting the sawing plane.

For further information on the System Specifications and Duty Cycle, please refer to page 76f.



Locked symbol
Drive unit is off for safety



ON
Drive unit is on for sawing

Insert saw blade

Insert a reciprocating saw blade into the coupling and push until the saw blade locks in place (Fig. 1).

Lightly pull the saw blade to ensure it is properly seated.

Adjust sawing plane

Pull the sliding sleeve back and rotate the saw head to adjust the sawing plane (adjustable through 360° in 45° increments, Fig. 2).

Release the sliding sleeve and turn the saw head slightly until it locks in place.

Remove saw blade

Turn the release knob in the direction of the arrow to eject the reciprocating saw blade (Fig. 3).



Figure 1



Figure 2



Figure 3

Instructions for handling saw blades

Synthes recommends using a new saw blade for each operation to ensure that the saw blade is optimally sharpened and clean.

The following risks are associated with used saw blades:

- Thermal necrosis caused by excessive heat build-up
- Infection caused by residues
- Extended cutting time due to poor sawing performance
- Potentially, splintering of the teeth or the saw blade

The use of irrigation fluid is recommended to cool the cutting tools and prevent heat necrosis.

Check the cutting tools for wear and/or damage after each use, and replace if necessary. For optimal performance, use Synthes saw blades only. These are optimized to meet the specific requirements of the tool. Non Synthes saw blades can considerably reduce the lifetime of the system.

Detailed ordering information on saw blades for the Battery Power Line II system can be found in the brochure "Saw Blades" (DSEM/PWT/0514/0004).

General Information

Power tool units and attachments are frequently exposed to high mechanical loads and shocks during use and should not be expected to last indefinitely. Proper handling and maintenance help extend the useful life of surgical instruments.

Gentle care and maintenance with proper lubrication can substantially increase the reliability and life of the system components and reduce the risk of malfunction or harm to the user and patient.

Synthes power tools must be serviced and inspected annually by the original manufacturer or an authorized site. Yearly maintenance will ensure that the equipment maintains the highest standard of performance and will prolong the life of the system. The manufacturer assumes no warranty for damages arising from improper use, neglected or unauthorized servicing of the tool.

For more information about Care and Maintenance, please refer to the Battery Power Line II Care and Maintenance Poster (DSEM/PWT/0147/0166).

Precautions:

- **Reprocessing must be performed immediately after each use.**
- **Cannulations, unlocking sleeves and other narrow sites require special attention during cleaning.**
- **Cleaners with a pH of 7–9.5 are recommended. The use of cleaners with higher pH-values can – depending on the cleaner – cause dissolution of the surface of aluminum, titanium and its alloys, plastics or compound materials. The use of such cleaners should be subject to the data regarding material compatibility in the corresponding data sheet.**
At pH values higher than 11, the surface of stainless steel can be affected.
For detailed information about material compatibility, refer to the document “Important Information” at <http://emea.depuysynthes.com/hcp/reprocessing-care-maintenance>. Please refer to the chapter “Material Compatibility of Synthes Instruments in Clinical Processing”. Concerning the clinical reprocessing of the BPL II system please refer to the following section of this document.
- **Follow the enzymatic cleaner instructions for use for correct dilution/concentration, temperature and water quality. Devices should be cleaned in a fresh, newly-made solution.**
- **Detergents used on the products will be in contact with the following materials: stainless steel, aluminum, plastic, and rubber seals.**
- **Never immerse the handpiece, batteries, battery casing or attachments in aqueous solutions or in an ultrasonic bath. Do not use pressurized water as this will cause damage to the system. The aseptic transfer is detailed on page 14ff. Alternatively please follow the guidelines provided in the STERRAD/V-PRO sterilization guide (DSEM/PWT/0615/0068). No other sterilization methods are allowed. The battery must never be washed, rinsed or dropped. This would destroy the battery with possible secondary damage.**
- **Synthes recommends using new sterile cutting tools for each operation. Refer to “Clinical Processing of Cutting Tools” (DSEM/PWT/0915/0082) for detailed clinical processing instructions.**

Unusual Transmissible Pathogens

Surgical patients identified as at-risk for Creutzfeldt-Jakob disease (CJD) and related infections should be treated with single-use instruments. Dispose of instruments, power tools and attachments used, or suspected to have been used, on a patient with CJD after surgery by incineration and/or follow current national recommendations.

Notes:

- **The clinical processing instructions provided have been validated by Synthes for preparing a non-sterile Synthes medical device; these instructions are provided in accordance with ISO 17664 and ANSI/AAMI ST81.**
- **Consult national regulations and guidelines for additional information. Furthermore, compliance with internal hospital policies and procedures and recommendations of manufacturers of detergents, disinfectants, and any clinical processing equipment is additionally required.**
- **Cleaning Agent Information: Synthes used the following cleaning agents during validation of these reprocessing recommendations: neutral pH enzymatic detergents (e.g. Steris Prolystica 2X Concentrate Enzymatic Cleaner). These cleaning agents are not listed in preference to other available cleaning agents which may perform satisfactorily.**
- **It remains the responsibility of the processor to ensure that the processing performed achieves the desired result using the appropriate, properly installed, maintained and validated equipment, materials and personnel in the processing unit. Any deviation by the processor from the instructions provided should be properly evaluated for effectiveness and potential adverse consequences.**

Cleaning and Disinfection

Preparation prior to Reprocessing

Disassembly

Before cleaning, remove all instruments and attachments from the power tool. Remove the battery casing from the handpiece and then remove the battery from the battery casing.

Cleaning and Disinfection of the battery and charger

1. To clean the battery and the charger, wipe them off with a clean, soft and lint-free cloth dampened with deionized water and dry prior to processing (Figs. 1 and 2).
2. To disinfect the battery and charger wipe them with a new, clean, soft and lint-free cloth dampened with a minimum of 70% alcohol-based disinfectant for thirty (30) seconds. A disinfectant that is VAH listed, EPA registered or locally recognized is recommended. This step has to be repeated two (2) additional times using a new, clean, soft and lint-free cloth dampened with a minimum 70% alcohol-based disinfectant each time. Follow the instructions provided by the manufacturer of the disinfectant.

Notes:

- **Take care not to spray the contacts or touch both contacts at the same time with the damp cloth due to danger of short circuiting.**
- **Inspect battery for cracks and damage.**

Return batteries to Universal Battery Charger II (05.001.204) after each use (Fig. 3).

Upon completion of charging the battery (indicated by the green LED illuminating), wipe the battery with a minimum 70% alcohol-based disinfectant prior to returning to use.

The aseptic transfer is detailed on page 14ff. Alternatively please follow the guidelines provided in the STERRAD/V-PRO sterilization guide (DSEM/PWT/0615/0068). No other sterilization methods are allowed.

Handpieces and attachments must be processed using

- manual cleaning
- automated cleaning with manual pre-cleaning

Note: Clean all movable parts in opened or unlocked position.



Figure 1



Figure 2



Figure 3

Cleaning and Disinfection

Manual Cleaning Instructions

1. Remove debris

Rinse the device under running cold tap water for a minimum of 2 minutes. Use a sponge, soft lint-free cloth or soft-bristled brush to assist in removing gross soil (Fig. 1). For cannulations of the handpiece and attachments, the cleaning brush (516.101) shown below should be used.

Notes:

- Do not use pointed objects for cleaning.
- Brushes and other cleaning tools shall be either single-use items or, if reusable, be decontaminated at least daily using a solution as detailed on page 49 in section “3. Spray and wipe”. Brushes shall be inspected before daily use and discarded if they have degraded to the point where they may scratch instrument surfaces or be ineffective due to worn or missing bristles.

Precaution: Never immerse the handpiece, batteries, battery casing or attachments in aqueous solutions or in an ultrasonic bath. Do not use pressurized water as this will cause damage to the system. The battery must never be cleaned following the manual cleaning instructions.

2. Manipulate moving parts

Manipulate all moving parts such as triggers, sliding sleeves, attachment release rings, saw blade coupling and switches under running tap water to loosen and remove gross debris.



Figure 1

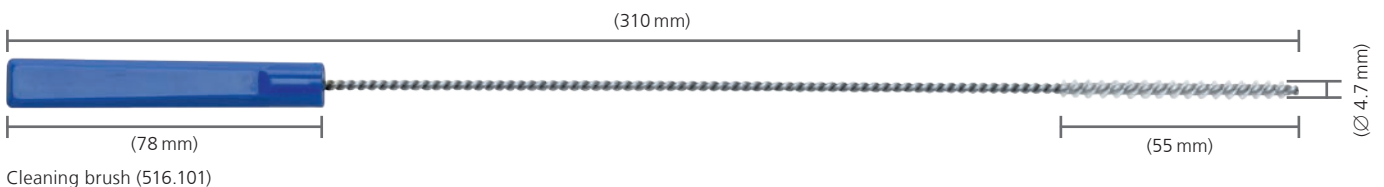

3. Spray and wipe

Spray and wipe the device using a neutral pH enzymatic solution for a minimum of 2 minutes (Fig. 2). Follow the enzymatic detergent manufacturer's directions for correct temperature, water quality (i.e. pH, hardness) and concentration/dilution.

4. Rinse with tap water

Rinse device with cold tap water for a minimum of 2 minutes. Use a syringe or pipette to flush lumens and channels.

5. Clean with detergent

Clean the device manually under running warm water using an enzymatic cleaner or detergent for a minimum of 5 minutes. Manipulate all moving parts under running water. Use a soft-bristled brush and/or soft lint-free cloth to remove all visible soil and debris (Figs. 3 and 4). Follow the enzymatic cleaner or detergent manufacturer's instructions for use for correct temperature, water quality and concentration/dilution.

Note: For the Quick Coupling for Pins \varnothing 3.2 mm (530.796) the brush should only be inserted from the front.



Figure 2



Figure 3



Figure 4: Quick Coupling for Kirschner Wires and for Pins \varnothing 1.5–4.0 mm (530.791)

6. Rinse with tap water

Rinse the device thoroughly using cool to lukewarm running water for a minimum of 2 minutes. Use a syringe or pipette to flush lumens and channels. Actuate joints, handles and other movable device features in order to rinse thoroughly under running water.

7. Wipe/Spray disinfection

Wipe off or spray the surfaces of the devices with a minimum of 70% alcohol-based disinfectant.

8. Visually inspect device

Inspect the cannulations, sliding sleeves, attachment release rings, etc. for visible soil. Repeat steps 1–8 if visible soil remains.

9. Final rinse with de-ionized/purified water

Final rinse with de-ionized or purified water for a minimum of 2 minutes (Fig. 7).

10. Dry

Dry device using a clean, soft lint-free cloth or medical grade compressed air (Fig. 8).



Figure 7



Figure 8

Cleaning and Disinfection

Automated Cleaning Instructions with Manual Pre-cleaning

Notes:

- Manual pre-cleaning prior to automated cleaning is important to ensure cannulations and other difficult to access areas are clean.
- Alternative cleaning procedures other than in the procedure described below (including manual pre-cleaning) have not been validated by Synthes.

1. Remove debris

Rinse the device under running cold tap water for a minimum of 2 minutes. Use a sponge, soft lint-free cloth or soft-bristled brush to assist in removing gross soil (Fig. 1). For cannulations of the handpiece and attachments, the cleaning brush (516.101) shown below should be used.

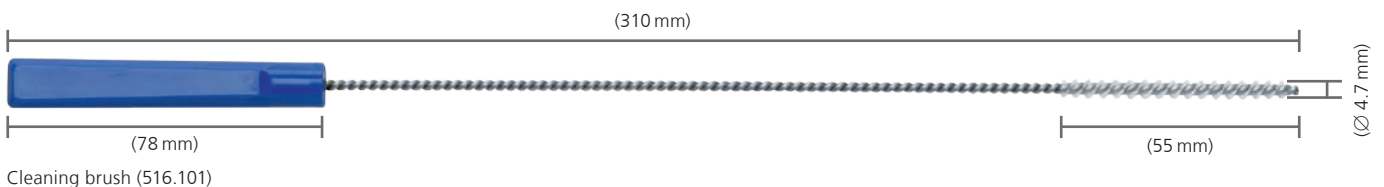

Figure 1

Notes:

- Do not use pointed objects for cleaning.
- Brushes and other cleaning tools shall be either single-use items or, if reusable, be decontaminated at least daily using a solution as detailed on page 52 in section “3. Spray and wipe”. Brushes shall be inspected before daily use and discarded if they have degraded to the point where they may scratch instrument surfaces or be ineffective due to worn or missing bristles.

Precaution: Never immerse the handpiece, batteries, battery casing or attachments in aqueous solutions or in an ultrasonic bath. Do not use pressurized water as this will cause damage to the system. The battery must never be cleaned following the automated cleaning with manual pre-cleaning instructions.



2. Manipulate moving parts

Manipulate all moving parts such as triggers, sliding sleeves, attachment release rings, saw blade coupling and switches under running tap water to loosen and remove gross debris.

3. Spray and wipe

Spray and wipe the device using a neutral pH enzymatic solution for a minimum of 2 minutes (Fig. 2). Follow the enzymatic detergent manufacturer's directions for correct temperature, water quality (i.e. pH, hardness) and concentration/dilution.

4. Rinse with tap water

Rinse device with cold tap water for a minimum of 2 minutes. Use a syringe or pipette to flush lumens and channels.

5. Clean with detergent

Clean the device manually under running warm water using an enzymatic cleaner or detergent for a minimum of 5 minutes. Manipulate all moving parts under running water. Use a soft-bristled brush and/or soft lint-free cloth to remove all visible soil and debris (Figs. 3 and 4). Follow the enzymatic cleaner or detergent manufacturer's instructions for use for correct temperature, water quality and concentration/dilution.

Note: For the Quick Coupling for Pins \varnothing 3.2 mm (530.796) the brush should only be inserted from the front.

6. Rinse with tap water

Rinse the device thoroughly using cool to lukewarm running water for a minimum of 2 minutes. Use a syringe or pipette to flush lumens and channels. Actuate joints, handles and other movable device features in order to rinse thoroughly under running water.

7. Visually inspect device

Inspect the cannulations, sliding sleeves, attachment release rings, etc. for visible soil. Repeat steps 1–7 if visible soil remains.



Figure 2



Figure 3



Figure 4: Quick Coupling for Kirschner Wires and for Pins \varnothing 1.5–4.0 mm (530.791)

8. Load Synthes Washing Basket

Please use the specially designed tray for machine washing as supplied by Synthes (68.001.620, 68.001.625). Follow the numbered loading plans as shown on pages 54 and 55. Ensure that the attachments are positioned in an upright position as shown and fully opened. This will ensure that the water can flow off any surfaces. Damage due to improper reprocessing is not covered by the warranty.

Notes:

- A lid (68.001.602, 68.001.604) is available for the washing basket. This can be used for sterilization, but is not required for machine washing.
- Do not wash the system in the Synthes Vario Case (689.202).
- **Loading Plan for Washing Basket Full Size $\frac{1}{4}$**
Washing Basket (68.001.620) with
Lid for Washing Basket (68.001.602) for BPL II

Dimensions (Length × Width × Height):

Washing Basket without Lid: 500 × 250 × 119 mm
Washing Basket with Lid: 504 × 250 × 150 mm

- **Loading Plan for Washing Basket size $\frac{1}{2}$**
Washing Basket (68.001.625) with
Lid for Washing Basket (68.001.604) for BPL II

Dimensions (Length × Width × Height):

Washing Basket without Lid: 252 × 250 × 119 mm
Washing Basket with Lid: 256 × 250 × 150 mm

Care and Maintenance
 Cleaning and Disinfection
 Automated Cleaning Instructions with Manual Pre-cleaning

68.001.620
 Washing Basket Full size 1/1

530.705
 Battery Reamer/Drill II or
 530.605 Battery Reamer/Drill

510.191
 Key for Drill Chuck
 (530.730 and 530.732)

BPL Attachments
 (BPL, BPL II)

530.690
 Battery Casing

530.660
 Sterile Cover

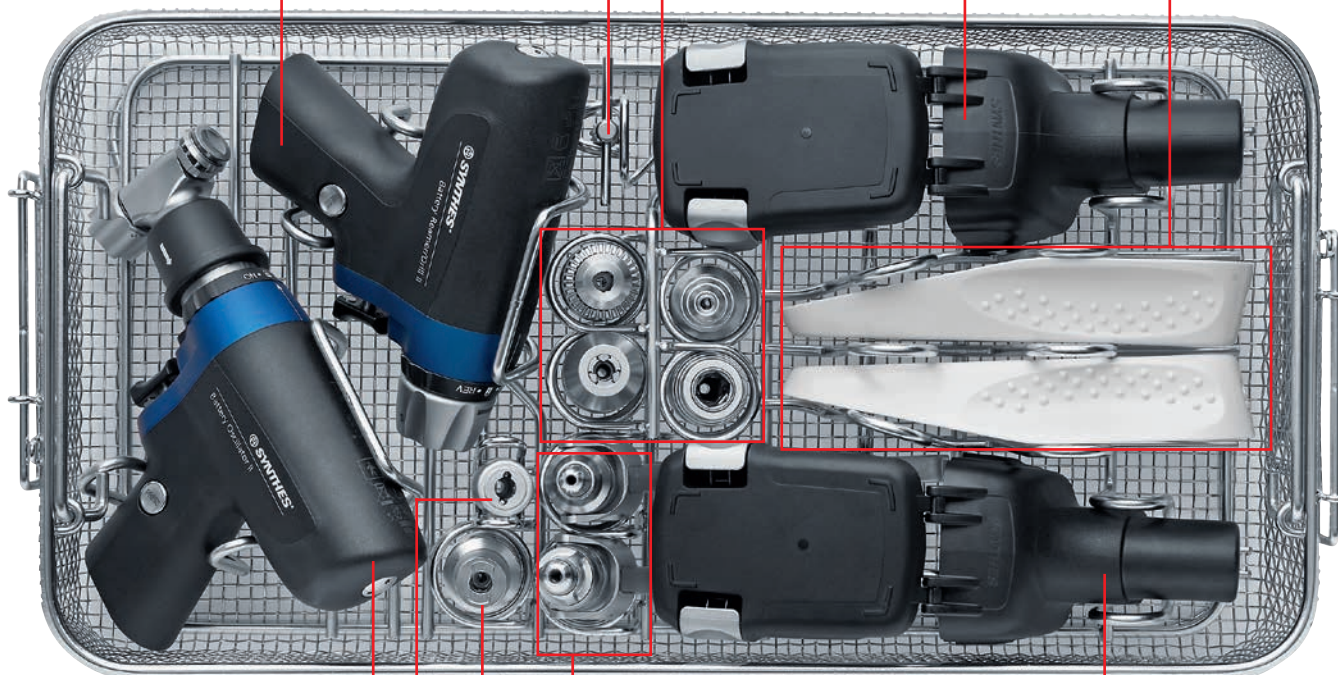

530.710
 Battery Oscillator II, or
 BPL II: 530.705 Battery Reamer/Drill II, or
 530.715 Battery Reciprocator II
 BPL: 530.605 Battery Reamer/Drill, or
 530.610 Battery Oscillator, or
 530.615 Battery Reciprocator

Two spots for 530.790, 530.791, 530.796 or
 any BPL Attachment (BPL, BPL II)

BPL Attachment (BPL, BPL II)

511.787 Küntscher Adapter or
 511.788 Harris Adapter

530.690
 Battery Casing

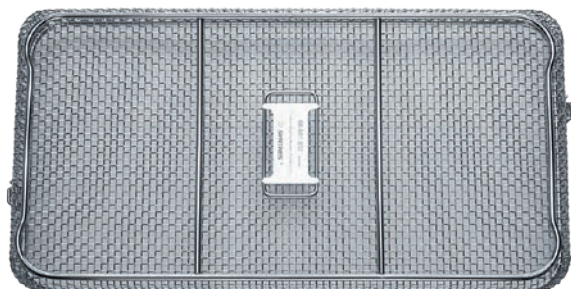

68.001.602
 Lid for Washing Basket size 1/1

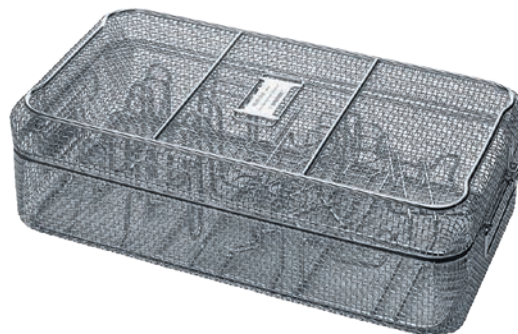

68.001.620 and 68.001.602

A loading plan for the BPL II Washing Basket Full size 1/1 is available as a single document (DSEM/PWT/1116/0127).

68.001.625

Washing Basket size 1/2



68.001.604
Lid for Washing Basket size 1/2



68.001.625 and 68.001.604

A loading plan for the BPL II Washing Basket size 1/2 is available as a single document (DSEM/PWT/1116/0128).

8. Automated cleaning cycle parameters

Note: The washer/disinfector should fulfill requirements specified in ISO 15883.

Step	Duration (minimum)	Cleaning Instructions
Rinse	2 minutes	Cold tap water
Pre-wash	1 minute	Warm water ($\geq 40^{\circ}\text{C}$); use detergent
Clean	2 minutes	Warm water ($\geq 45^{\circ}\text{C}$); use detergent
Rinse	5 minutes	Rinse with de-ionized (DI) or purified water (PURW)
Thermal disinfection	5 minutes processing	Hot DI water, $\geq 90^{\circ}\text{C}$
Dry	40 minutes	$\geq 90^{\circ}\text{C}$

9. Inspect device

Remove all devices from the washing basket.

Inspect the cannulations, sliding sleeves, etc. for visible soil. If necessary, repeat the manual pre-cleaning/automated cleaning cycle. Confirm that all parts are completely dry both inside and outside. A reduction of the dry time may lead to damage to the electrical components in the power tool due to the presence of moisture. Such damage will not be covered by warranty.

Precaution: Mechanical cleaning is an additional stress for power equipment, especially for seals and bearings. Therefore, devices must be properly lubricated after automated cleaning. Furthermore, the device must be serviced at least once per year as specified under the section “Repair and Technical Services” on page 67.

Maintenance and Lubrication

To ensure a long service life and smooth operation, it is necessary that the accessible moving parts of the hand-piece, battery casing and attachment are lubricated after each use with 1 drop of Synthes Special Oil (519.970). Spread the oil by moving the components. Wipe off excess oil with a cloth.

Failing to lubricate the parts will lead to damage and malfunction, increasing the risk of harm to the user and patient.

For further information on lubrication, please refer to the Instruction for Use of the Synthes Special Oil 519.970 (60099544) and the BPL II Care and Maintenance Poster (DSEM/PWT/0147/0166).

The lubrication of individual parts is described in further detail on the following pages.

Battery Reamer/Drill II (530.705)

The following individual parts must be lubricated with 1 drop of Synthes Special Oil (519.970):

- 1 Attachment release ring (Figs. 1a and 1b)
- 2 Trigger shaft. After application of lubricant press the trigger several times.
- 3 Rear end of the cannulation (Fig. 3)

Turn the attachment release ring clockwise and insert 1 drop of Synthes Special Oil (519.970) as shown in figure 1a. Then turn the release ring several times.

Insert 1 drop of Synthes Special Oil (519.970) in the gap between the seal ring and shaft (Fig. 1b). Insert the battery pack and run handpiece to ensure oil is evenly distributed.

Lubricate battery casing release buttons from the inside, after which the buttons should be pressed several times (Fig. 2)



Figure 1a

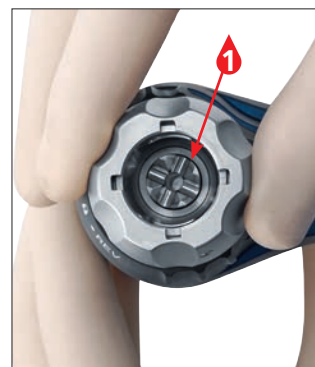

Figure 1b

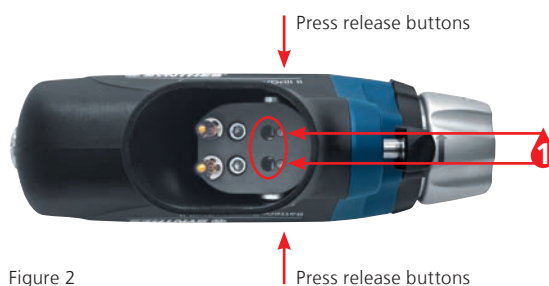

Figure 2



Figure 3

Battery Oscillator II (530.710)

The following individual parts must be lubricated with

- 1 drop of Synthes Special Oil (519.970):
- 1 Saw blade coupling
- 2 Locking knob for the saw blade quick coupling
- 3 Sliding sleeve for positioning the saw blade (Figs. 1a and 1b)
- 4 Trigger shaft. After application of lubricant press the trigger several times.

Pull the sliding sleeve back and put 1 drop of Synthes Special Oil (519.970) on the exposed area (Fig. 1a). Then push the sleeve forward and put 1 drop of oil on the other exposed area (Fig. 1b). To lubricate push the sleeve forward and backwards several times. Then pull back the sliding sleeve and rotate the saw head several times.

Lubricate battery casing release buttons from the inside, after which the buttons should be pressed several times (Fig. 2)



Figure 1a



Figure 1b



Figure 2

Battery Reciprocator II (530.715)

The following individual parts must be lubricated with

- 1 drop of Synthes Special Oil (519.970):
 - 1 Saw blade coupling
 - Sliding sleeve for positioning the saw blade (Figs. 1a and 1b)
 - Trigger shaft. After application of lubricant press the trigger several times.

Pull the sliding sleeve back and put 1 drop of Synthes Special Oil (519.970) on the exposed area (Fig. 1a). Then push the sleeve forward and put 1 drop of oil on the other exposed area (Fig. 1b). To lubricate push the sleeve forwards and backwards several times. Then pull back the sliding sleeve and rotate the saw head several times.

Battery casing release buttons from the inside, after which the buttons should be pressed several times (Fig. 2)



Figure 1a



Figure 1b



Figure 2

Lubricating the battery casing (530.690)

Place oil on the complete inside edge of the battery casing and distribute it evenly. Open and close the lid several times to lubricate the sealing. Wipe off excess oil with a cloth (Fig. 1).



Battery Casing for Battery Power Line II (530.690)



Figure 1

Lubricating the attachments

After each use lubricate all moving parts of the attachment with 1 drop of Synthes Special Oil (519.970) (Figs. 1a and 1b).

Spread the oil by moving the components. Wipe off excess oil with a cloth.

Insert 1 drop of Synthes Special Oil (519.970) in the gap between the seal ring and shaft of the attachment coupling (Fig. 2a and 2b). Connect the attachment to the Battery Reamer/Drill II and let it run while the attachment tip is facing downward.

For further information on lubrication, please refer to the Instruction for Use of the Synthes Special Oil 519.970 (60099544) and the BPL II Care and Maintenance Poster (DSEM/PWT/0147/0166).

Precautions:

- To ensure a long service life and reduce repairs, the handpieces, attachments and battery casings must be lubricated after each use.
- Only lubricate the handpieces, battery casings and attachments when clean.
- **Exception:** The Radiolucent Drive (511.300) does not require lubrication.
- The power tools and attachments must only be lubricated with Synthes Special Oil (519.970). No oil from other manufacturer must be used. Lubricants with other compositions may cause jamming, have a toxic effect or have a negative impact on the sterilization results.



Figure 1a

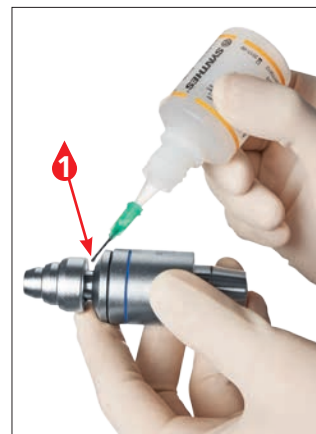

Figure 1b



Figure 2a

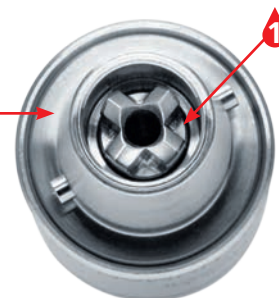
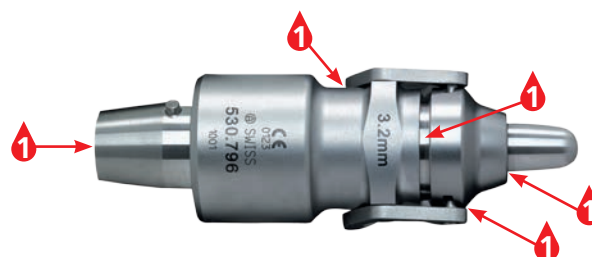

Figure 2b



Quick Coupling for Kirschner Wires and for Pins
Ø 1.5–4.0 mm (530.791)



Quick Coupling for Pins Ø 3.2 mm (530.796)

Inspection and Function Test

Instructions

Visually inspect for damage and wear (e.g. unrecognizable markings, missing or removed part numbers, corrosion, etc.).

Check the handpiece controls for smooth operation and function.

All movable parts should be moving smoothly. Check that the triggers do not remain blocked in the handpiece when pressing on them. Check that no residuals prevent the movable parts from moving smoothly.

Check the release ring of the handpiece and attachments for smooth operation, and check for function together with cutting tools.

Check instruments and cuttings tools for correct adjustment and functioning prior to every use.

Do not use damaged, worn or corroded components but send them instead to the Synthes Service Center.

Failing to follow these instructions will lead to damage and malfunction, increasing the risk of harm to the user and patient.

For further information on inspection and function test, please refer to the BPL II Care and Maintenance Poster (DSEM/PWT/0147/0166).

Packaging, Sterilization and Storage

Packaging

Put cleaned and dry products into their proper places in the Synthes Vario Case (689.202, Figs. 1a–1d) or the Synthes Washing Baskets (68.001.620, 68.001.625, Figs. 2a and 2b). Additionally, use an appropriate sterilization wrap or re-usable rigid container system for sterilization, such as a Sterile Barrier System according to ISO 11607. Care should be taken to prevent pointed and sharp instruments from contact with other objects that may damage the surface or the Sterile Barrier System.

Loading Plan for Vario Case size 1/1 for BPL II

Vario Case (689.202) with lid (689.507)

Dimensions (Length × Width × Height):

Vario Case: 477 × 250 × 133 mm

Lid: 477 × 250 × 5 mm

Highest point 133 mm is determined by the top of the handles



Lid for VarioCase size 1/1



689.202 and 689.507



Figure 1b
(upper part)



Figure 1a (bottom part)



Figure 1c
(upper part)



Figure 1d (fully loaded Vario Case)



Figure 2a:
Fully loaded Washing Basket Full size 1/1 (68.001.620)



Figure 2b:
Fully loaded Washing Basket size 1/2 (68.001.625)

For further information on the Washing Baskets please refer to pages 53–55.

Sterilization

Precautions:

- Remove batteries from battery casings.
- The aseptic transfer is detailed on page 14ff. Alternatively please follow the guidelines provided in the STERRAD/V-PRO sterilization guide (DSEM/PWT/0615/0068). No other sterilization methods are allowed.

Notes:

- If the Vario Case (689.202) is sterilized in a sterilization wrap, use the lid (689.507).
- If the Washing basket (68.001.620, 68.001.625) is sterilized in a sterilization wrap, use the lid (68.001.602, 68.001.604).
- If the Vario Case (689.202) is sterilized in a rigid container, the lid (689.507) is not required.
- If the Washing basket (68.001.620, 68.001.625) is sterilized in a rigid container, the lid (68.001.602, 68.001.604) is not required.

Synthes Battery Power Line II system must be resterilized using validated steam sterilization methods (ISO 17665 or national standards). Synthes recommendations for packed devices and cases are as follows.

Cycle type	Sterilization exposure time (minutes)	Sterilization exposure temperature	Dry time (minutes)
Saturated steam-forced air removal (pre-vacuum)	Minimum 4	Minimum 132°C Maximum 138°C	20–60
	Minimum 3	Minimum 134°C Maximum 138°C	20–60

Drying times generally range from 20 to 60 minutes due to differences in packaging materials (Sterile Barrier System, e.g., wraps or re-usable rigid container systems), steam quality, device materials, total mass, sterilizer performance and varying cool-down time.

Precautions:

- The following maximum values must not be exceeded: 138°C over a maximum of 18 minutes. Higher values can damage the sterilized products.
- Observe the packages prior to storage for visual moisture or dampness and if found on or within the pack, the product should be repackaged and sterilized with an increased drying time.
- Do not accelerate the cooling process as it will damage the electronic components of the power tool and could result in harm to the user and patient.
- Hot air, ethylene oxide, plasma and formaldehyde sterilization are not recommended.

Storage

Storage conditions for products labeled "STERILE" are printed on the packaging label.

Packaged and sterilized products should be stored in a dry, clean environment, protected from direct sunlight, pests, and extremes of temperature and humidity. Use products in the order in which they are received ("first-in, first-out principle"), taking note of any expiration date on the label.

Repairs and Technical Service

The power tool should be sent to the Synthes office for repair if it is faulty or malfunctions.

Contaminated products have to run through the complete reprocessing procedure before being sent to the Synthes office for repair or technical service.

To prevent damage during shipping use the original packaging to return devices back to Synthes. If the packing material is no longer available, please contact the Synthes affiliate.

This system requires regular maintenance service, at least once a year, in order to maintain its functionality. This service has to be performed by the original manufacturer or an authorized site.

Faulty devices must not be used. If it is no longer possible or feasible to repair the power tool it should be disposed of, cf. the following section "Disposal of Waste".

Other than the above-mentioned care and maintenance, no further maintenance work is to be carried out independently or by third parties.

Please refer to the regulations for transporting Li-Ion batteries when returning them to the Synthes Service Center.

The manufacturer excludes liability for damage resulting from improper use, neglected or unauthorized maintenance or servicing of the tool.

Disposal of Waste

In most cases, faulty power tools can be repaired (refer to the previous section “Repairs and Technical Service”).

Please send devices that are no longer used to your local Synthes representative. This ensures that they are disposed of in accordance with the national application of the respective directive. The device must not be disposed of with household waste.

To prevent damage during shipping use the original packaging to return devices back to Synthes. If this is not possible, please contact the Synthes affiliate.

Faulty batteries must not be reused and should be disposed of in an environmentally friendly manner and in accordance with national regulations.

The European Battery Directive 2006/66/EC applies to this device. This device contains Lithium-Ion batteries that should be disposed of in accordance with environment protection requirements. Please observe national regulations.



The European directive 2012/19/EC on waste electrical and electronic equipment (WEEE) applies to this device. This device contains materials that should be disposed of in accordance with environment protection requirements. Please observe national regulations.



Precaution: Contaminated products have to run through the complete reprocessing procedure in order to rule out any risk of infection in case of disposal. Always discharge the batteries and isolate the contacts before disposal.

Warnings: Risk of fire, explosion and burns. Do not disassemble, crush, heat above 60°C/140°F or incinerate the battery cells.

Never expose batteries to temperatures over 60°C/140°F. The maximum exposure time at 60°C/140°F is 72 hours.

Do not dismantle, open or shred batteries.

Troubleshooting

General

Problem	Possible causes	Solution
Drive unit does not start	No battery in the drive unit	Insert charged battery
	Battery is discharged	Charge or replace battery
	Battery is defect	Replace battery
	If the drive unit is defect (e.g. short-circuited) do not insert a battery as this will blow the internal fuse and cause damage to the battery. If the UBCII had indicated that the battery was in working condition (green LED illuminating) this indicates that the drive unit is defective and the damage was not caused by the battery.	Send drive unit and battery to Synthes Service Center
	Drive unit did not cool down after sterilization	Allow to cool to room temperature
	Mode switch is set to «lock» (off position)	Set mode switch to ON/FWD/REV
	No electrical contact between drive unit and battery casing	Reinsert or change battery casing
Drive unit lacks power	Battery is not fully charged or past life cycle	Charge or replace battery
	Wrong attachment used (e.g. drilling speed vs. reaming speed)	Change attachment
	Drive unit has not been properly serviced	Send drive unit to Synthes Service Center
	Attachments have not been properly serviced	Send attachments to Synthes Service Center
Drive unit suddenly stops	Drive unit has overheated	Allow to cool to room temperature
	Battery is empty/discharged	Charge or replace battery
	If the drive unit is defect (e.g. short-circuited) do not insert a battery as this will blow the internal fuse and cause damage to the battery. If the UBCII had indicated that the battery was in working condition (green LED illuminating) this indicates that the drive unit is defective and the damage was not caused by the battery.	Send drive unit to Synthes Service Center

Problem	Possible causes	Solution
Drive unit continues to run after releasing trigger	Trigger is jammed by residue	Immediately turn mode switch to "lock" (off position) or remove the battery casing Precaution: Clean and lubricate trigger according to care and maintenance guidelines
	Drive unit is defective	Immediately turn mode switch to "lock" (off position) or remove the battery casing Send drive unit to Synthes Service Center
Drive unit or attachment becomes excessively hot	Drive unit or attachment is used outside the specification	Allow drive unit or attachment to cool. (see Duty cycles on page 76)
	The cutting tool is blunt	Replace the cutting tool
Visible physical damage on items	Battery was accidentally reprocessed	Replace battery. Send damaged battery to Synthes Service Center
	Drive unit, attachment, battery casing, sterile cover was dropped	Replace damaged items. Send damaged items to Synthes Service Center
Battery is faulty	Staff negligence	Replace battery and send the battery to Synthes Service Center. Do not use a faulty or damaged battery, as this may damage the power tool. Test the status of the battery using the Universal Battery Charger II (DSEM/PWT/1114/0050).
Battery casing jams when inserting or removing from drive unit	Coupling mechanism has not been lubricated	Clean and lubricate according to care and maintenance guidelines
	Coupling mechanism is damaged	Send damaged item to Synthes Service Center
Battery casing lid is difficult to open and close	Sealing ring has not been lubricated	Clean and lubricate according to care and maintenance guidelines

Battery Reamer/Drill II

Problem	Possible causes	Solution
Attachments cannot couple to drive unit	Coupling is blocked by residue	Precaution: Immediately turn mode switch OFF (Lock position). Remove solid particles with pick-ups. Clean and lubricate according to care and maintenance guidelines.
	Attachment coupling is damaged	Send damaged attachment to Synthes Service Center
Difficulty removing attachments from drive unit	Coupling is blocked by residue	Precaution: Immediately turn mode switch OFF (Lock position). Remove solid particles with pick-ups. Clean and lubricate coupling sleeve according to care and maintenance guidelines.
	Drive unit coupling sleeve is damaged	Send damaged drive unit to Synthes Service Center
Bone, cutting tool and drive unit heat up during surgery	The cutting tool is blunt	Replace the tool

Battery Oscillator II

Problem	Possible causes	Solution
Saw blade is difficult to couple or cannot be coupled	General wear and tear has affected the connection geometry of the saw blade	Replace the saw blade
Bone and drive unit heat up during surgery	The cutting teeth of the saw blade are blunt	Replace the saw blade
Battery Oscillator II vibrates too intensively	Saw blade locking mechanism is not tight	Tighten the locking knob on the saw blade quick coupling

Battery Reciprocator II

Problem	Possible causes	Solution
Saw Blade is difficult to couple or cannot be coupled	General wear and tear has affected the connection geometry of the saw blade	Replace the saw blade
Bone and drive unit heat up during surgery	The cutting teeth of the saw blade are blunt	Replace the saw blade

Attachments and Cutting Tools

Problem	Possible causes	Solution
Attachments cannot couple to drive unit	Coupling is blocked by residue	Precaution: Immediately turn mode switch OFF (Lock position). Remove solid particles with pick-ups. Clean and lubricate according to care and maintenance guidelines.
Difficulty removing attachments from drive unit	Release sleeve for attachments is jammed/blocked by residue	Precaution: Immediately turn mode switch OFF (Lock position). Remove solid particles with pick-ups. Check the release sleeve; clean and lubricate if necessary (Synthes Special Oil 519.970). Send machine to Synthes Service Center if necessary.
Cutting tool is difficult to couple or cannot be coupled to an attachment	The attachment or cutting tool is deformed from wear	Replace the attachment or cutting tool, or send it to a Synthes Service Center
Attachment becomes excessively hot	Attachment is used too long	Allow attachment to cool (see Duty cycles on page 76)
Rotating attachment turns too slowly	Wrong attachment used (e.g. reaming speed vs. drilling speed)	Change attachment
Kirschner wire cannot be inserted into the Kirschner wire attachment	Kirschner wire attachment is not opened far enough	Fully open the adjustment sleeve on the attachment, insert the Kirschner wire and close the adjustment sleeve
Kirschner wire cannot be secured despite pulling the tension lever	Kirschner wire attachment is opened too far	Close the adjustment sleeve on the attachment until the wire is fixed
Kirschner wire is jammed in the attachment and cannot be moved	Kirschner wire was inserted at an angle and is jammed in the attachment	Send Kirschner wire attachment to Synthes Service Center

Problem	Possible causes	Solution
Guide pin cannot be inserted into the front of the Quick Coupling for Pins attachment (530.796) or cannot be grasped	Diameter or shaft geometry is unsuitable	Quick Coupling for Pins (530.796) allows insertion and removal of Ø 3.2 mm guide pins with round, triangular or flat shafts only
Bone and cutting tool becomes excessively hot	Cutting tool is blunt	Replace cutting tool

If the recommended solutions do not work, send the power tool to your local Synthes Service Center.

For further technical questions or information on our services, please contact your Synthes representative.

For troubleshooting for the Universal Battery Charger II please consult the relevant instructions for use (DSEM/PWT/1114/0050).

System Specifications

The device meets the following standards

Medical electrical equipment – Part 1: General requirements for basic safety and essential performance:

- IEC 60601-1 (2012) (Ed. 3.1),
- EN 60601-1 (2006) + A11 + A1 + A12,
- ANSI/AAMI ES60601-1:2005/(R)2012,
- CAN/CSA-C22.2 NO. 60601-1:14

Medical electrical equipment – Part 1–2: Collateral Standard: Electromagnetic disturbances – Requirements and tests:

- IEC 60601-1-2 (2014) (Ed. 4.0),
- EN 60601-1-2 (2015)

Medical electrical equipment – Part 1–6: Collateral Standard: Usability:

- IEC 60601-1-6 (2010) (Ed. 3.0) + A1 (2010)



E352266

Medical General Medical Equipment as to electrical shock, fire and mechanical hazards only in accordance with:
ANSI/AAMI ES60601-1 (2005) + AMD 1 (2012)
CAN/CSA-C22.2 No. 60601-1 (2014)

	Operation	Storage
Temperature		
Relative humidity		
Atmospheric pressure		
Altitude	0–5000 m	0–5000 m

Transportation*

Temperature	Duration	Humidity
–29 °C; –20 °F	72 h	uncontrolled
38 °C; 100 °F	72 h	85 %
60 °C; 140 °F	6 h	30 %

*products have been tested according to ISTA 2A

Warning: The machine must not be stored or operated in explosive atmospheres.

Duty Cycle

Intermittent operation type S9, according to IEC 60034-1



	Xs on	Ys off	Cycles
Drilling and tapping threads	60 sec	60 sec	5
Kirschner wire and pin setting	30 sec	90 sec	5
Reaming	60 sec	60 sec	5
Oscillating Sawing	30 sec	90 sec	5
Reciprocating Sawing	20 sec	120 sec	5

Generally, electrical systems will heat up if in constant use. For this reason the handpiece and the attachments should be allowed to cool for at least 60 seconds (Ys off) following the time of constant use (Xs on) as outlined on the table above. After a certain amount of cycles (defined in the above table under "Cycles") the handpiece and attachment should be allowed to cool down. Observing this instruction prevents the system from overheating and possibly harming the patient or user. The user is responsible for the application and for turning off the system as prescribed. If longer periods of constant use are required, an additional handpiece and/or attachment should be used.

Depending on the cutting tool used and the load applied, the heat generated by the handpiece, attachment and/or cutting tool can vary.

Precautions:

- Carefully observe the above recommended duty cycles.
- Always control the temperature of the system to prevent overheating and possibly harming the patient or user.
- Above mentioned duty cycles can be reduced due to higher loads applied and due to ambient temperatures above 20°C/68°F. This needs to be taken into consideration during the planning of the surgical intervention.
- Always use new cutting tools to prevent heating up of the system due to reduced cutting performance.
- Cutting tools must be cooled with irrigation fluid to prevent heat necrosis. For this purpose, irrigate manually.
- Careful maintenance of the system will reduce heat build-up in the handpiece and the attachments.
- The Battery Power Line II must not be stored or operated in an explosive atmosphere.

**Declaration of the emission sound pressure level
and the sound power level according to EU**

Directive 2006/42/EC

Measurement of the sound pressure level [LpA] is carried out in accordance with standard EN ISO 11202.

Measurement of the sound power level [LwA] is carried out in accordance with standard EN ISO 3746.

Handpiece	Attachment	Cutting Tool	Sound Pressure Level (LpA) in [dB(A)]	Sound Power Level (LwA) in [dB(A)]	Max. daily exposure time without hearing protection
Battery Reamer/Drill II* 530.705	Drill/Ream*	–	61	70	> 8 h
Battery Oscillator II** 530.710	–	Saw blade 519.170	85	97	8 h
	–	Saw blade 05.002.105	90	102	2 h 31 min
Battery Reciprocator II*** 530.715	–	Saw blade 511.905	87	98	5 h 02 min

Operation condition:

* Handpiece 530.705 with 530.796 at idle speed (930 rpm)

** Handpiece 530.710 at idle speed (12.000 Osc./min)

*** Handpiece 530.715 at idle speed (14.000 Osc./min)

Technical data is subject to tolerances.

The values are determined with Synthes saw blades.

**Declaration of vibration emission according to EU
Directive 2002/44/EC**

Vibration emissions [m/s^2] tested according to
EN ISO 5349-1.

Handpiece	Attachment	Cutting Tool	Vibration emission [m/s^2]	Max. daily exposure time to reach limit value [2.5 m/s^2]	Max. daily exposure time to reach limit value [5 m/s^2]
Battery Reamer/Drill II* 530.705	Drill/Ream*	–	0.22	>8 h	>8 h
Battery Oscillator II** 530.710	–	Saw blade 519.170	4.51	2 h 27 min	>8 h
	–	Saw blade 05.002.105	12.1	20 min	1 h 21 min
Battery Reciprocator II*** 530.715		Saw blade 511.905	9.74	31 min	2 h 06 min

Operation condition:

* Handpiece 530.705 with 530.796 at idle speed (930 rpm)

** Handpiece 530.710 at idle speed (12.000 Osc./min)

*** Handpiece 530.715 at idle speed (14.000 Osc./min)

Technical data is subject to tolerances.

The values are determined with Synthes saw blades.

Electromagnetic Compatibility

Accompanying Documents According to IEC 60601-1-2, 2014, ed. 4.0

Table 1: Emissions

**Guidance and manufacturer's declaration –
electromagnetic emissions**

The Battery Power Line II (BPL II) System is intended for use in the electromagnetic environment specified below. The customer or the user of the BPL II System should assure that it is used in such an environment.

Emission test	Compliance	Electromagnetic environment – guidance
RF emissions CISPR 11	Group 1	The BPL II System uses RF energy only for its internal function. Therefore, its RF emissions are very low and are not likely to cause any interference in nearby electronic equipment.
RF emissions CISPR 11	Class B	The BPL II System is suitable for use in professional healthcare facility environment but not in home healthcare or special environment.
Harmonic emissions IEC 61000-3-2	Not applicable	
Voltage fluctuations/flicker emissions IEC 61000-3-3	Not applicable	

Table 2: Immunity (all devices)**Guidance and manufacturer's declaration –
electromagnetic immunity**

The BPL II System is intended for use in the electromagnetic environment specified below. The customer or the user of BPL II System should assure that it is used in such an environment.

Immunity test standard	IEC 60601 test level	Compliance level	Electromagnetic environment – guidance
Electrostatic discharge (ESD) IEC 61000-4-2	±8 kV contact ±15 kV air	±8 kV contact ±15 kV air	Floors should be wood, concrete or ceramic tile. If floors are covered with synthetic material, the relative humidity should be at least 30%.
Electrical fast transient/burst IEC 61000-4-4	± 2 kV for power supply lines	Not applicable	Mains power quality should be that of a typical commercial or hospital environment.
Surge IEC 61000-4-5	±1 kV line to line ±2 kV line to earth	Not applicable	Mains power quality should be that of a typical commercial or hospital environment.
Voltage dips, short interruptions and voltage variations on power supply lines IEC 61000-4-11	< 5% UT (0.5 cycle) 40% UT (5 cycles) 70% UT (25 cycles) < 5% UT for 5 s	Not applicable	Mains power quality should be that of a typical commercial or hospital environment.
Note: UT is the a.c. mains voltage prior to application of the test level.			
Power frequency (50/60 Hz) magnetic field IEC 61000-4-8	30 A/m	200 A/m	Power frequency magnetic fields should be at levels characteristic of a typical location in a typical commercial or hospital environment.

Table 4: Immunity (not life-supporting devices)

**Guidance and manufacturer’s declaration –
electromagnetic immunity**

The BPL II System is intended for use in the electromagnetic environment specified below. The customer or the user of the BPL II System should assure that it is used in such an environment.

Precaution: Use of this equipment adjacent to or stacked with other equipment should be avoided because it could result in improper operation.

Electromagnetic environment – guidance

Portable and mobile RF communications equipment should be used no closer to any part of the BPL II System, including cables, than the recommended separation distance calculated from the equation applicable to the frequency of the transmitter.

Immunity test standard	IEC 60601 test level	Compliance level	Recommended separation distance^e
Conducted RF IEC 61000-4-6	3 Vrms 150 kHz to 80 MHz	Not applicable	$d \pm 0.35 \sqrt{P}$ 150 kHz to 80 MHz
Radiated RF IEC 61000-4-3	3 V/m 80 MHz to 800 MHz	$E1 \pm 10$ V/m 80 MHz to 800 MHz	$d \pm 0.35 \sqrt{P}$ 80 MHz to 800 MHz
Radiated RF IEC 61000-4-3	3 V/m 800 MHz to 2.5 GHz	$E2 \pm 10$ V/m 800 MHz to 2.7 GHz	$d \pm 0.7 \sqrt{P}$ 800 MHz to 6.2 GHz

Where P is the maximum output power rating of the transmitter in watts (W) according to the transmitter manufacturer and d is the recommended separation distance in meters (m).

Field strengths from fixed RF transmitters, as determined by an electromagnetic site survey,^a should be less than the compliance level in each frequency range.^b

Interference may occur in the vicinity of equipment marked with the following symbol:



Note 1: At 80 MHz and 800 MHz, the higher frequency range applies.

Note 2: These guidelines may not apply in all situations. Electromagnetic propagation is affected by absorption and reflection from structures, objects and people.

- a Field strengths from fixed transmitters, such as base stations for radio (cellular/cordless) telephones and land mobile radios, amateur radio, AM and FM radio broadcast and TV broadcast cannot be predicted theoretically with accuracy. To assess the electromagnetic environment due to fixed RF transmitters, an electromagnetic site survey should be considered. If the measured field strength in the location in which the BPL II System is used exceeds the applicable RF compliance level above, the BPL II System or the device, which contains it should be observed to verify normal operation. If abnormal performance is observed, additional measures may be necessary, such as re-orienting or relocating the device containing the BPL II System.
- b Over the frequency range 150 kHz to 80 MHz, field strengths should be less than 10 V/m.
- c Possible shorter distances outside ISM bands are not considered to have a better applicability of this table.

Table 5: Recommended separation distances (not life-supporting devices)

Recommended separation distances between portable and mobile RF communications equipment and the BPL II System

The BPL II System is intended for use in the electromagnetic environment in which radiated RF disturbances are controlled. The customer or the user of the BPL II System can help prevent electromagnetic interference by maintaining a minimum distance between portable and mobile RF communications equipment (transmitters) and the BPL II System as recommended below, according to the maximum output power of the communication equipment.

Separation distance according to frequency of transmitter

Rated maximum output power of transmitter (W)	150 kHz to 80 MHz $d \pm 0.35 \sqrt{P}$	80 MHz to 800 MHz $d \pm 0.35 \sqrt{P}$	800 MHz to 6.2 GHz $d \pm 0.7 \sqrt{P}$
0.01	0.04 m	0.04 m	0.07 m
0.1	0.12 m	0.12 m	0.23 m
1	0.35 m	0.35 m	0.7 m
10	1.11 m	1.11 m	2.3 m
100	3.5 m	3.5 m	7 m

For transmitters rated at a maximum output power not listed above, the recommended separation distance d in meters (m) can be estimated using the equation applicable to the frequency of the transmitter, where P is the maximum output power rating of the transmitter in watts (W) according to the transmitter manufacturer.

Note 1: At 80 MHz and 800 MHz, the separation distance for the higher frequency range applies.

Note 2: These guidelines may not apply in all situations. Electromagnetic propagation is affected by absorption and reflection from structures, objects and people.

Note 3: An additional factor of 10/3 is used in calculating the recommended separation distance to decrease the likelihood that mobile/portable communications equipment could cause interference if it is inadvertently brought into patient areas.

Ordering Information

Drive units

530.705	Battery Reamer/Drill II
530.710	Battery Oscillator II
530.715	Battery Reciprocator II

Charger, Battery and Accessories for Battery

05.001.204	Universal Battery Charger II
530.630	Battery for Battery Power Line II
530.660	Sterile Cover for Battery Power Line II
530.690	Battery Casing for Battery Power Line II

Attachments

530.750	AO/ASIF Quick Coupling, for Battery Power Line
530.730	Drill Chuck (930 1/min), with Key (clamping range 0.5 to 7.3 mm), for Battery Power Line
530.731	Drill Chuck, keyless (clamping range 0.5 to 7.3 mm), for Battery Power Line
530.792	Hudson Quick Coupling (930 1/min), for Battery Power Line
530.793	Trinkle Quick Coupling (930 1/min), modified, for Battery Power Line
530.794	Trinkle Quick Coupling (930 1/min), for Battery Power Line
530.760	Quick Coupling for DHS/DCS Triple Reamers, for Battery Power Line
530.732	Drill Chuck (340 1/min), with Key (clamping range 0.5 to 7.3 mm), for Battery Power Line
530.782	Hudson Quick Coupling (340 1/min), for Battery Power Line
530.783	Trinkle Quick Coupling (340 1/min), modified, for Battery Power Line
530.784	Trinkle Quick Coupling (340 1/min), for Battery Power Line
530.795	Trinkle Quick Coupling XXL (340 1/min) modified, for Battery Power Line
530.780	AO/ASIF Quick Coupling for Reamers, for Battery Power Line
530.791	Quick Coupling for Kirschner Wires and for Pins Ø 1.5–4.0 mm
530.796	Quick Coupling for Pins Ø 3.2 mm
530.741	Adapter for RDL for Battery Power Line
511.300	Radiolucent Drive for use with 530.741
511.787	Kuentscher Adapter
511.788	Harris Adapter
510.191	Spare Key for Drill Chuck, clamping range up to Ø 7.3 mm

Vario Case and Washing Basket

689.202	Vario Case size 1/1 for Battery Power Line II, without lid, without contents
689.507	Lid (Stainless Steel), size 1/1, for Vario Case
68.001.620	Washing Basket, Full Size 1/1, for Battery Power Line II
68.001.602	Lid for Washing Basket, Full Size 1/1
68.001.625	Washing Basket, size 1/2, for Battery Power Line II
68.001.604	Lid for Washing Basket, size 1/2

Accessories

516.101	Cleaning brush for APL II/BPL/TRS
519.970	Oil dispenser with Synthes special oil
DSEM/PWT/0147/0166	Care and Maintenance Poster for Battery Power Line II

For further information please contact your local DePuy Synthes representative.

Cutting tools

Detailed ordering information on the saw blades for the BPL II system can be found in the brochure "Large Bone Saw Blades" (DSEM/PWT/0514/0004).

Detailed ordering information on the special 3-flute drill bits for the Radiolucent Drive can be found in the brochure "Working with the Radiolucent Drive" (DSEM/PWT/0417/0167).

STERRAD/V-PRO sterilization

STERRAD/V-PRO sterilization guide (DSEM/PWT/0615/0068).

Example Battery Power Line II Set – Joint Replacement

Instruments	Quantity
05.001.204 Universal Battery Charger II	1
530.705 Battery Reamer/Drill II	1
530.710 Battery Oscillator II	1
530.715 Battery Reciprocator II	1
530.630 Battery for Battery Power Line II	3
530.660 Sterile Cover for Battery Power Line II	3
530.690 Battery Casing for Battery Power Line II	3
530.796 Quick Coupling for Pins Ø 3.2 mm	1
530.730 Drill Chuck (930 1/min), with Key (clamping range 0.5 to 7.3mm)	1
530.782 Hudson Quick Coupling (340 1/min)	1
530.783 Trinkle Quick Coupling (340 1/min), modified	1

Vario Case and Washing Basket

689.202 Vario Case size 1/1 for Battery Power Line II, without lid, without contents	1
689.507 Lid (Stainless Steel), size 1/1, for Vario Case	1
68.001.620 Washing Basket, Full Size 1/1, for Battery Power Line II	1
68.001.602 Lid for Washing Basket, Full Size 1/1	1
68.001.625 Washing Basket, size 1/2, for Battery Power Line II	1
68.001.604 Lid for Washing Basket, size 1/2	1

Example Battery Power Line II Set – Trauma

Instruments	Quantity
05.001.204 Universal Battery Charger II	1
530.705 Battery Reamer/Drill II	1
530.710 Battery Oscillator II	1
530.630 Battery for Battery Power Line II	2
530.660 Sterile Cover for Battery Power Line II	2
530.690 Battery Casing for Battery Power Line II	2
530.730 Drill Chuck (930 1/min), with Key (clamping range 0.5 to 7.3 mm)	1
530.750 AO/ASIF Quick Coupling, for Battery Power Line	1
530.760 Quick Coupling for DHS/DCS Triple Reamers, for Battery Power Line	1
530.791 Quick Coupling for Kirschner Wires and for Pins Ø 1.5–4.0 mm	1

Vario Case and Washing Basket

689.202 Vario Case size 1/1 for Battery Power Line II, without lid, without contents	1
689.507 Lid (Stainless Steel), size 1/1, for Vario Case	1
68.001.620 Washing Basket, Full Size 1/1, for Battery Power Line II	1
68.001.602 Lid for Washing Basket, Full Size 1/1	1



Not all products are currently available in all markets.

This publication is not intended for distribution in the USA.

For full user instructions and precautions please consult the product IFU. Please contact your DePuy Synthes sales representative for more information.

All surgical techniques are available as PDF files at www.depuysynthes.com/ifu